

IdentDef

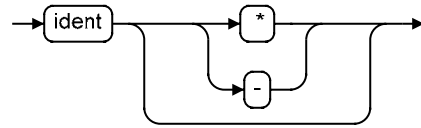

IdentList

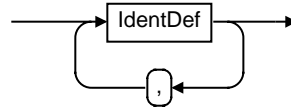

ExprList

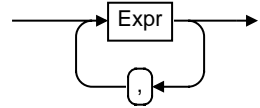

Qualident

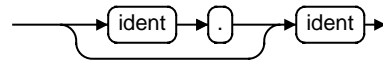

Designator

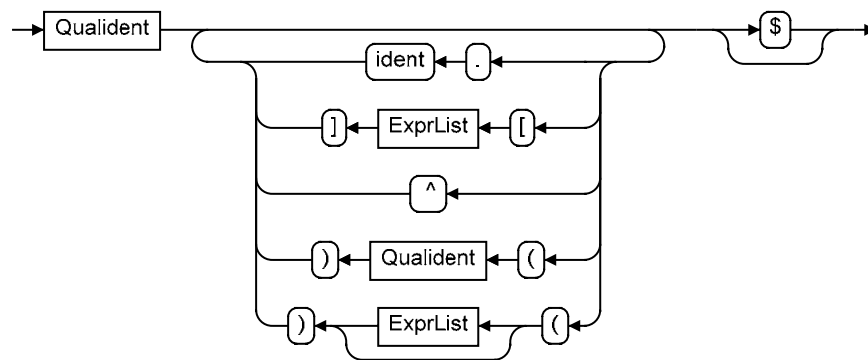

Relation

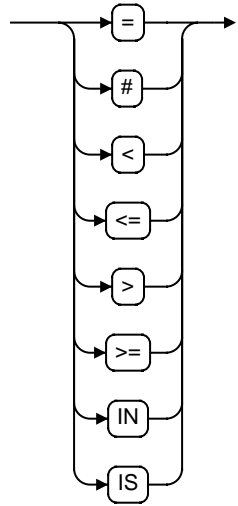

MulOp

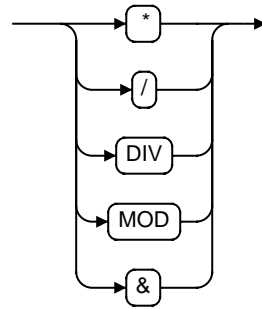

AddOp

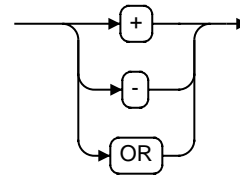

Element

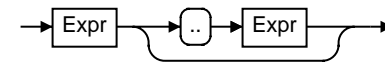

Factor

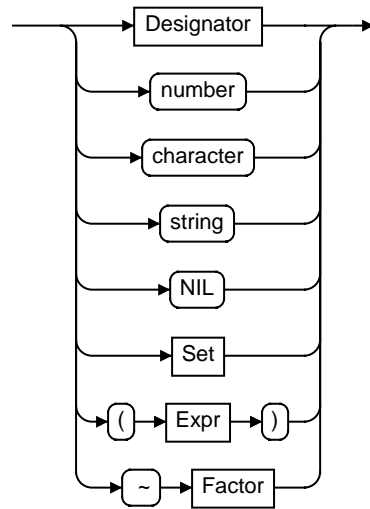

Set

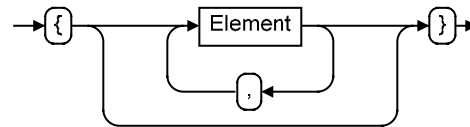

Term

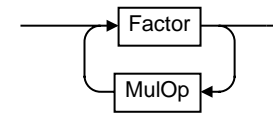

SimpleExpr

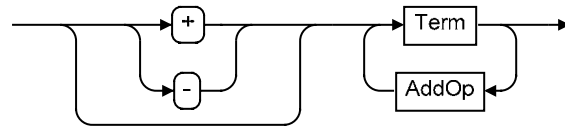

Expr

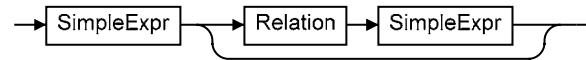

ConstExpr



Guard

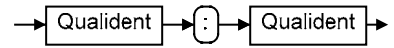

CaseLabels

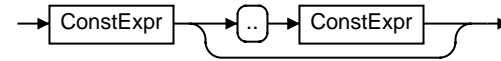

Case

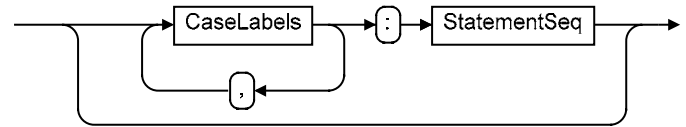

Statement

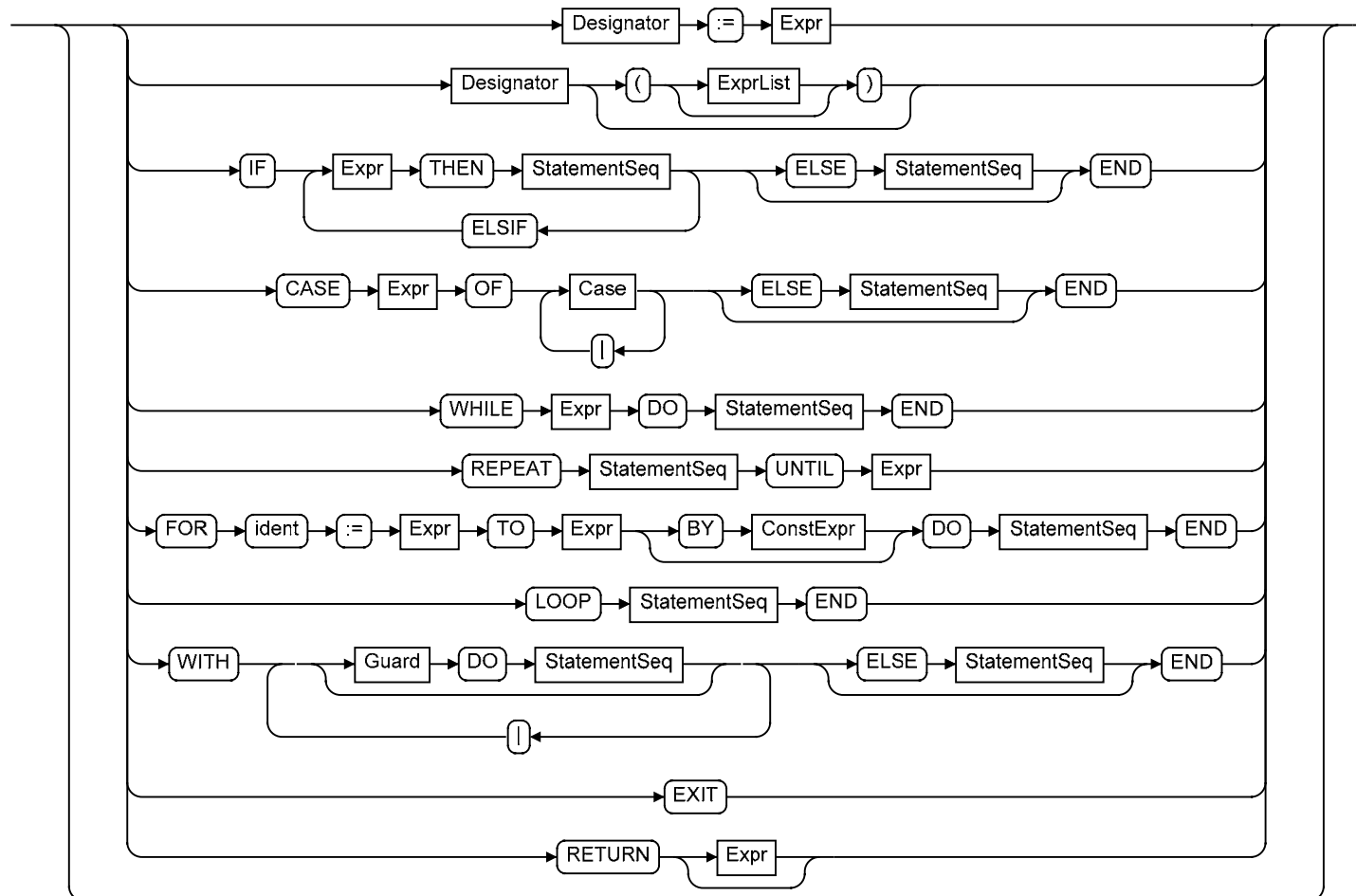

FieldList

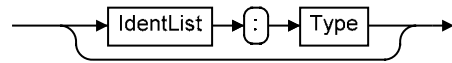

Type

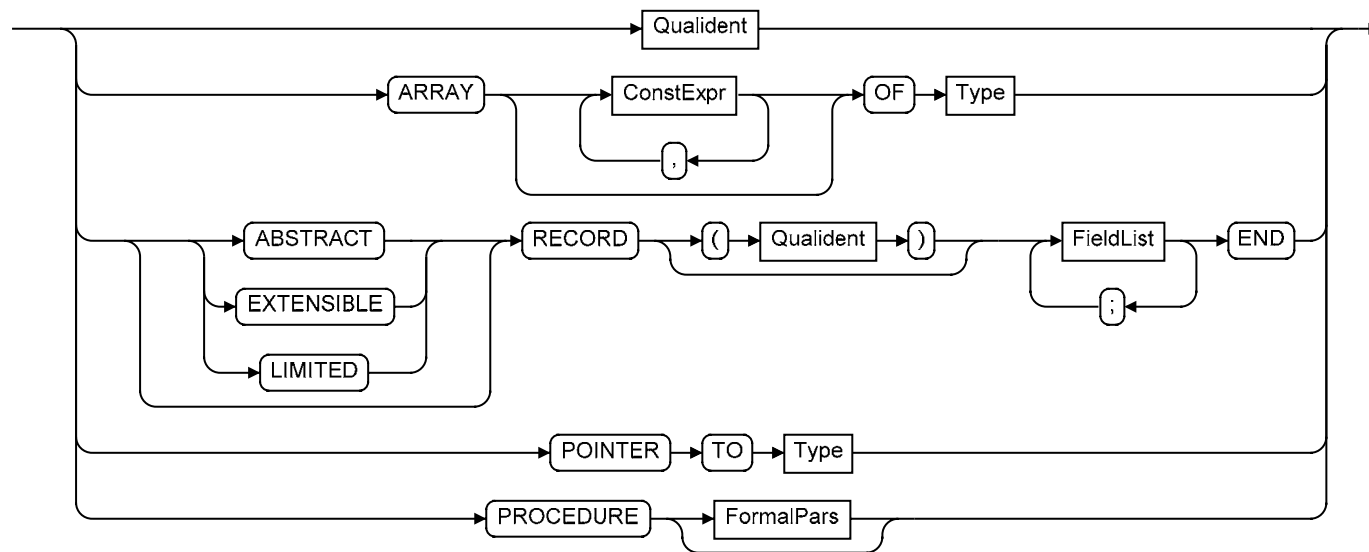

FPSection

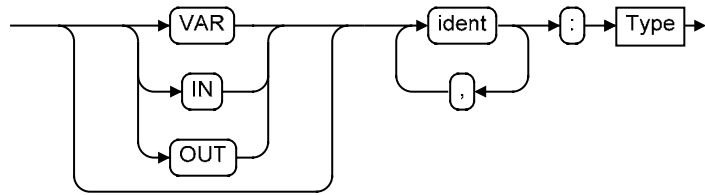

Receiver

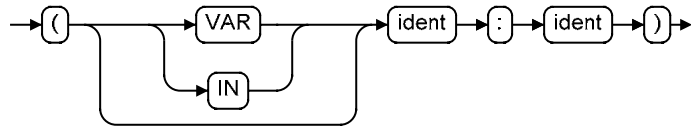

FormalPars

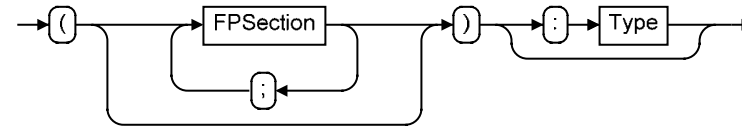

ForwardDecl

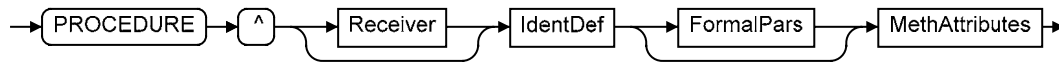

MethAttributes

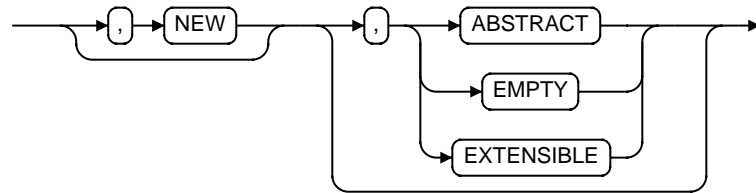

ProcDecl

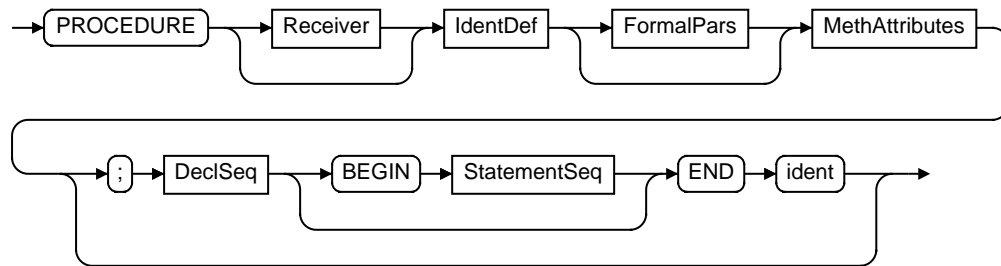

VarDecl

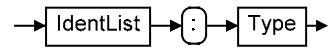

TypeDecl

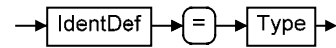

ConstDecl

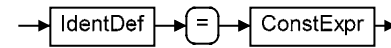

DeclSeq

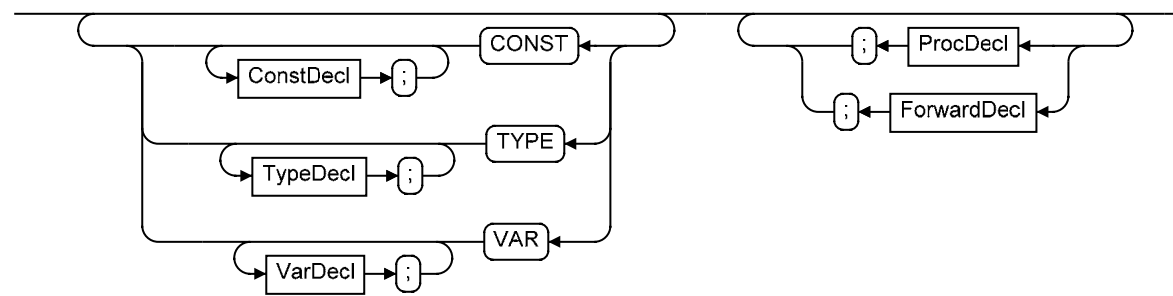

ImportList

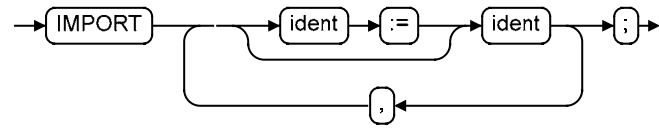

Module

